

Raspberry Pi 4B/3B/3B+/2B

Ras p-On

Power Management / RTC (Real Time Clock)

# User's Manual Rev 4.0

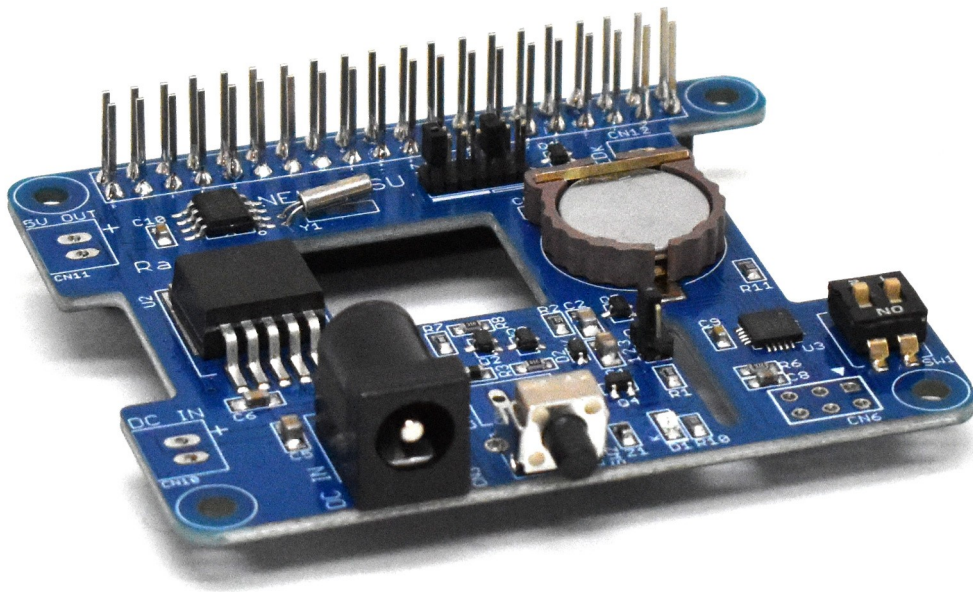

Power Management

Power Regulator

AC adapter connection with DC jack

RTC (Real Time Clock)

# NEKORISU

# CHAPTER 1 INTRODUCTION

How to use, how to set up and FAQ are described to use “Ras p-On” properly on this Manual. Please read this to make “Ras p-On” perform well and use it safely for sure.

## What’s “Ras p-On”

“Ras p-On” is an add-on board which adds 3 functions to Raspberry Pi.

### ① Power Switch Control is Add-On

Raspberry Pi has no power Switch. So plug/unplug is needed to power ON/OFF.

“Ras p-On” adds power switch to Raspberry Pi.

- Pushing down power switch boots Raspberry Pi.
- Raspberry Pi is powered off safely after power switch is pushed down and shutdown command is executed.
- Forced shutdown is enable,

Thus Ras p-On makes it easy to handle Raspberry Pi same as PC

The power switch function of “Ras p-On” works with the dedicated software. Shutdown command is notified to OS when the power switch is pushed down. Power supply is turned off safely after shutdown process is done completely and which is notified.

The software to perform these functions is executed as service.

(The operation of Raspberry Pi isn’t affected as the software is executed in background.)

The software needed can be installed by the dedicated installer.



Caution) Power supply is automatically shut off in about 30 seconds unless the dedicated software is installed.

## ② Power Supply Regulator is Add-On

5.1V/2.5A is recommended as the power supply of Raspberry Pi and the plug is micro-USB. (USB Type-C@Raspberry Pi 4B)

The power supply adapter is almost only genuine actually and it needs a lot of care to get. Also USB plugs are easily broken while using repeatedly.

DC Jack easy to use is adopted as power supply plug on “Ras p-On”. Thus various kinds of AC adapter commercially available can be used.

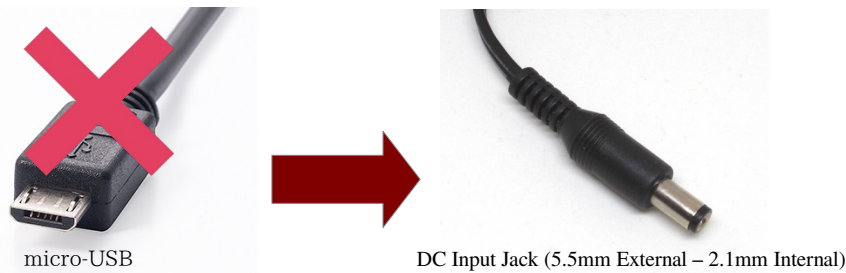

AC adapters from 6V to 25V can be used without limiting output of AC adapter to 5.1V as a regulator is equipped on power supply circuit.

Which allows power supply to Raspberry Pi to be 5.1V always for sure.

AC adapters handheld or available easily at low price can be used.

(\*Refer to “Handling Precautions of Power Supply” at the end of this document (Over 3A AC adapters are recommended to make Raspberry Pi perform well.))

## ③RTC(Real Time Clock) is Add-On

Raspberry Pi has no clock battery backed up (Real Time Clock), so the clock loses time after cutting off power supply.

Therefore RTC coin battery backed up (Real Time Clock) is equipped.

Thus it always keeps the right time even if power supply to Raspberry Pi is cut off.

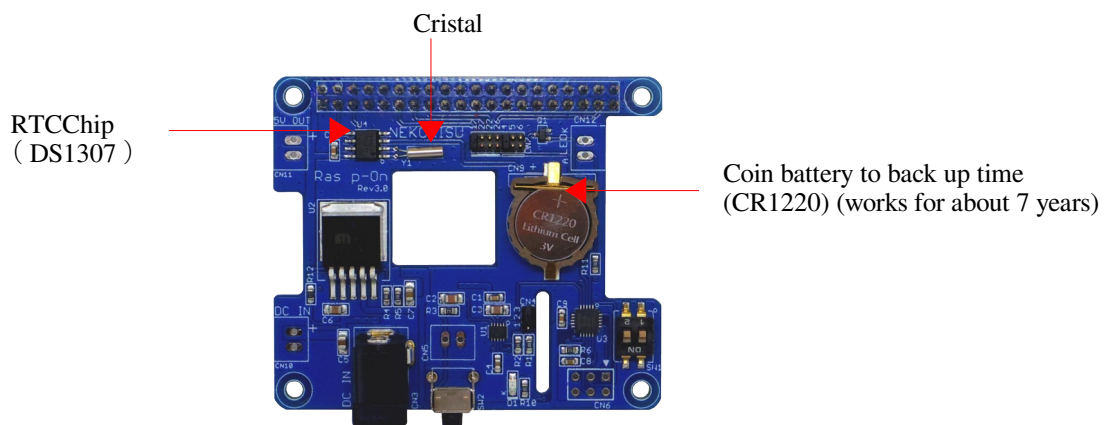

## CHAPTER 2 SET UP

To set up “Ras p-On”, follow these steps.

### ① Prepare Raspberry Pi.

Prepare Raspberry Pi.

The versions of Raspberry Pi enable to use are Raspberry Pi 4 model B (8GB, 4GB, 2GB), Raspberry Pi 3 model B / B+ or Raspberry Pi 2 model B.



Raspberry Pi 4B/3B/3B+/2B

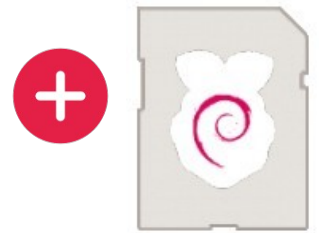

Raspberry Pi OS (Raspbian)

Install Raspberry Pi OS (Raspbian) in the SD card to make it work properly.

- ※ The installer for "Ras p-On" can be used on only Raspberry Pi OS (Raspbian).
- ※ OS except Raspberry Pi OS (Raspbian) can also operate, although the software by installer cannot be set up. Manual set up is needed when using the other OS.
- ※ Check out the data sheet about operation confirmed.

### ② Attach the spacers included to Raspberry Pi.

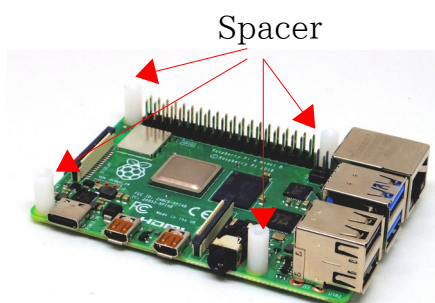

Attach the spacers included in “Ras p-On” package in the four corners of Raspberry Pi. Screw them from behind the board.

---

### ③ Connect “Ras p-On”

---

Connect “Ras p-On” to Raspberry Pi.

Adjust 40-pin pin headers to each other, attach with care not to be bended.

Put the pin header deeply, and fix the screws included on the four corners.

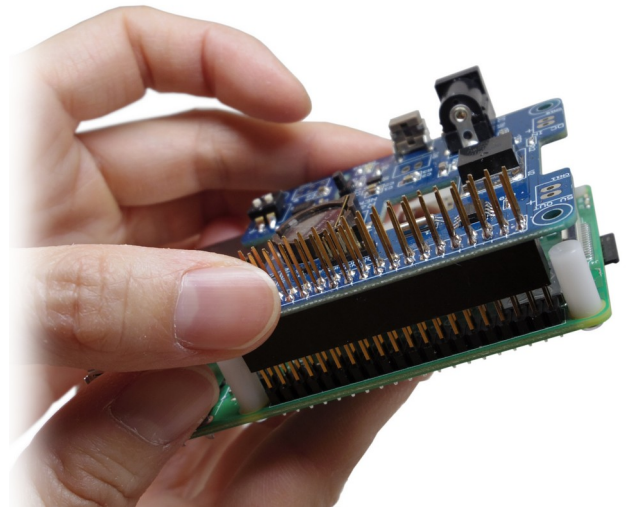

---

### ④ Have DIP switch ON.

---

Set both DIP switches to ON not to power off during software installation.

Set both of the DIP switches to ON as shown in the picture to the right.

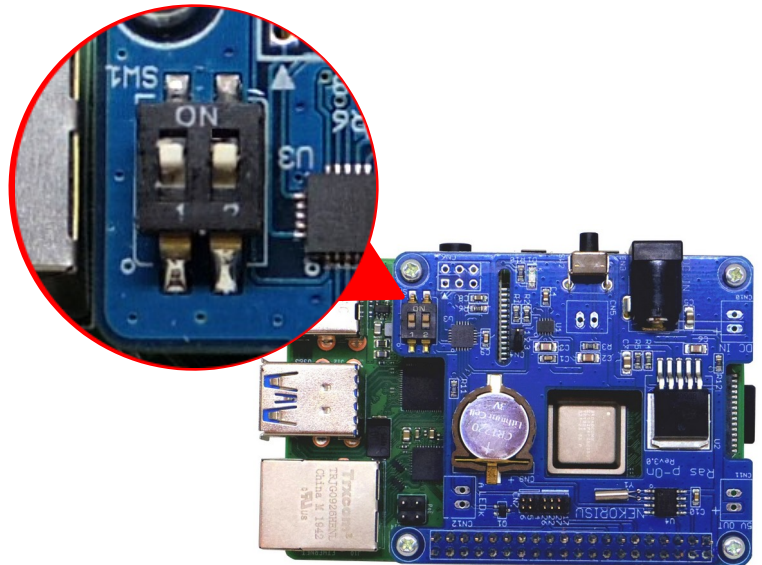

※ Refer to the data sheet for more details of setting the DIP switches.

---

## ⑤ Connect peripheral devices

---

- Connect display, keyboard and mouse.  
Set up by remote control via SSH connection is not needed.
- Connect LAN.  
WiFi connection can be used on Raspberry Pi 4B / 3B / 3B+.

Connection to the Internet is needed in installing the software.



\*Refer to Appendix in the end of this manual for procedure to set up without the Internet connection.

---

## ⑥ Connect AC adapter and power on.

---

- Connect DC Jack of AC adapter.  
Plug AC adapter into outlet.
- Push the power switch.
- Power supply green LED turns on  
and Raspberry Pi boots up.

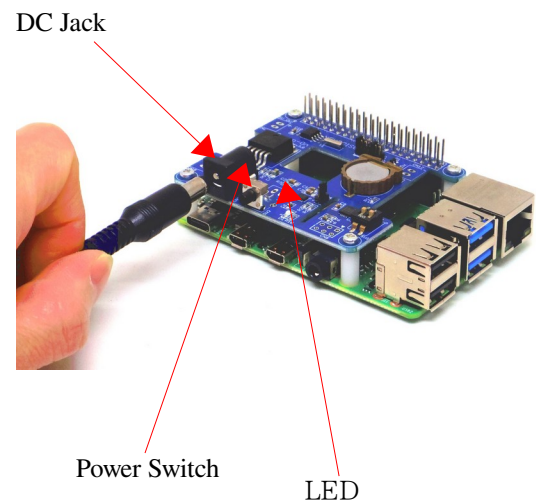

---

## ⑦ Install the software

---

Activate Terminal and execute following commands and install the software after Raspberry Pi boots.

(The software can be installed via SSH by remote control.)

※ Do not input comments texted in green.

```
#Make a work folder.  
mkdir raspon  
cd raspon  
#Download the installer and decompress it.  
wget http://www.nekorisu-embd.com/download/raspon-installer.tar.gz  
tar xzpvf raspon-installer.tar.gz  
#Execute install.  
sudo apt-get update  
sudo ./install.sh
```

---

## ⑧ Reset DIP switch.

---

Reset the DIP switch to the original position from those changed in the procedure ④.

Set both positions of the DIP switches to OFF as shown in the picture to the right.

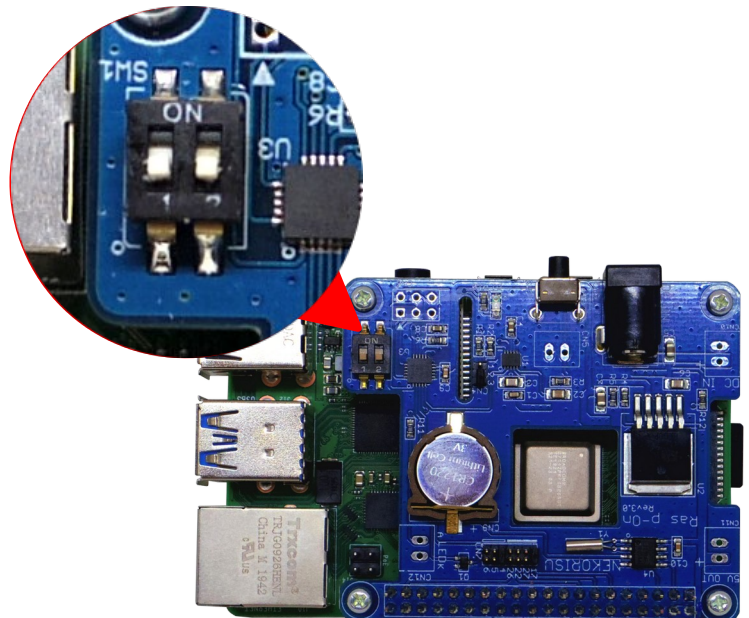

“Ras p-on” is ready for use!

Reboot Raspberry Pi.

# CHAPTER 3 OPERATION

## ① Power ON/OFF

- Power ON

Push the power switch.

Raspberry Pi is powered and boots up.

- Power OFF

A. Push the power supply switch of “Ras p-On”.

Shutdown is requested to OS and then shutdown is automatically executed.

Power is OFF after shutdown process is completed.

B. Shutdown via the menu or by command of Raspberry Pi.

Power is OFF automatically after the system detects shutdown is completed.

- Forced shutdown

Remain the power switch down over 3s.

Power is forced to be OFF.

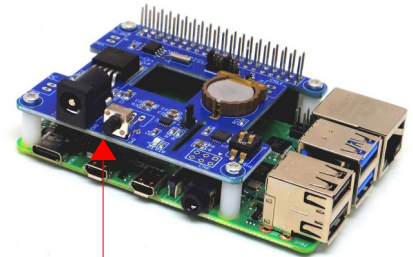

Power switch

### Reference)

The green power LED blinks while waiting for shutdown to be completed when the system detects shutdown of Raspberry Pi.



---

## ② How to set the clock

---

“Ras p-On” has a clock (Real Time Clock) backed up by battery. Thus it keeps the right time even if power of Raspberry Pi is OFF

The software installed in setting up reads the time “Ras p-On” has and set it as the system time automatically. Thus Raspberry Pi keeps the right time.

Moreover the software obtain current time from NTP server and correct the time when it can access to NTP server on the Internet in booting.

Also it can confirm, update or set current time “Ras p-On” has by executing the commands as follows:

```
# Confirm current time of “Ras p-On”
sudo hwclock -r

# Set current time of “Ras p-On” as system time
sudo hwclock -s

# Obtain current time from NTP server and write it into “Ras p-On”
sudo ntpdate xxxxxxxxxxxx    (<---xxxxxxxxx is the address of NTP server)
sudo hwclock -w

# Set current time manually and write it into “Ras p-On”
sudo date -s “2018-09-01 12:00:00”
sudo hwclock -w
```

# Appendix

---

## FAQ

---

**Q1 “Ras p-On” power off immediately even if powered on.**

**A1** The dedicated software for “Ras p-On” is not installed properly.  
Please install it following the set-up procedure of this manual.

**Q2 The power supply will be cut off in the middle of installing for updating OS version.**

**A2** “Ras p-On” doesn’t recognize Raspberry Pi is working in installing OS and thus it cuts off power supply. Please set both of the DIP switches ON in installing OS or before the dedicated software for “Ras p-On” is completely installed.

**Q3 “Ras p-On” cannot be powered off even if power supply switch is pushed down after immediately booting.**

**A3** Power supply switch operation cannot be accepted for 30s after immediately power on to prevent erroneous operation.

**Q4 Power supply will not cut off in spite of shutdown**

**A4** Both of the DIP switches are ON.  
Please set both OFF.

**Q5 Power supply cuts off and Raspberry Pi does not reboot while rebooting.**

**A5** The power supply can be cut off in rebooting on condition that process of OS shutdown and reboot takes much time.  
Please change the waiting time of “Ras p-On” by the DIP switches in such as this situation. (Refer to the data sheet for more details of setting the DIP switches.)  
The waiting time is can be changed by the dedicated software in case of that the power supply cuts off in rebooting despite of changing the position of the DIP switches. Up to 2 minutes extends is enable at most. Please refer to the data sheet for more details.

**Q6 What kind of AC adapters can be used?**

**A6** Confirm output voltage, maximum output current and shape of plug.  
\*Output Voltage is from 6v to 25V.  
\*Maximum output Current is over than 2.5A.  
\*Shape of plug is 5.5mm(external) – 2.1mm(internal)  
AC Adapter over 3A is recommended for maximizing performance of Raspberry Pi 4B / 3B+.  
Design a system with sufficient heat release when using AC Adapter over 6V.  
For more details, free to check out “Handling Precautions of Power Supply” at the end of this document.

## **Q7 The circuit of “Ras p-On” gets very hot.**

**A7** If high voltage AC Adapter is used, which results in heat loss and peripheral circuit of the power supply gets hot. Please think about heat release such as heat sink if high voltage power supply is used. The function of thermal shutdown activates if the temperature rises to 85 °C. With caution for burn.

For more details, free to check out “Handling Precautions of Power Supply” at the end of this document.

## **Q8 Is a coin battery needed?**

**A8** “Ras p-On” has a coin battery to make the time of real time clock on it. No coin battery is needed for operation without the real time function.

## **Q9 Can the coin battery be replaced?**

**A9** Yes. Please replace it with “coin type lithium battery CR1220” commercially available.

## **Q10 Can the dedicated software be installed without the Internet?**

**A10** Connection to the Internet is needed for setting up “Ras p-On” normally.

There are two reasons why as follows:

- \* Download of install files are needed.
- \* Installing ntpdate command is needed.

Setting up by the following procedure is able under condition that connection to the Internet is really difficult to get.

- ① Download the install files needed for set up in advance using PC with Internet connection is available. Those files can be downloaded on our Web site  
“[http://www.nekorisu-embd.com/ras\\_p-on\\_products.html](http://www.nekorisu-embd.com/ras_p-on_products.html) ”  
by using browsers or by using the following command  
“ wget <http://www.nekorisu-embd.com/download/raspon-installer.tar.gz> ”.
- ② Save the files downloaded to a USB flash memory and then connect it to Raspberry Pi.
- ③ Set up on Raspberry Pi by the following procedure:  
sudo tar xzpvf raspon-installer.tar.gz  
sudo ./install.sh -local

Notes) The function of time correction using NTP server is disable when setting up following the above procedure.

**Q11 Please show uninstalling the dedicated software.**

**A16** It is able to uninstall completely by the following commands:

```
sudo systemctl stop pwrctl.service  
sudo systemctl disable pwrctl.service  
sudo systemctl stop rtcsetup.service  
sudo systemctl disable rtcsetup.service  
sudo rm -r /usr/local/bin/raspon
```

**Q12 Is there any occupied GPIO on “Ras p-On”?**

**A17** The GPIO on “Ras p-On” are used by default as follows:

GPIO17 for detection of shutdown

GPIO4 for notification of shutdown

These GPIO can be changeable.

Refer to the data sheet for more details.

## The caution in handling of Power Supply

- ① Take care not to use the Micro-USB/USB Type-C on Raspberry Pi in power supply on “Ras p-On”. Raspberry Pi 4B / 3B+ don't have any circuits for reverse current protection, thus Power supply from Micro-USB/USB Type-C on Raspberry Pi could be a cause of damage to them, although that couldn't be a cause of damage on “Ras p-On” because of its circuit for reverse current protection. (The protection circuit is equipped on Raspberry Pi 3 model B, Raspberry Pi 2 model B.)
- ② Use wires over 3A-5W rated current in supplying power from the connector of TypeB add-on board. Some wires, Jacks, connectors cannot supply sufficient power to Raspberry Pi or the peripheral circuits. Use JST XHP-2 as housing to fit the DC IN connector. Make sure the polarity and wire properly.
- ③ 6V/3A power supply is highly recommended for the add-on board. A linear regulator is adapted as regulator of the add-on board, thus all the loss of power supply is released as heat loss. For example, if 24V power supply is used,  $(24V - 6V) \times 3A = 54W$  and thus the maximum power loss becomes 54W amount of heat loss. This indicates amount of heat which leads to 100°C in tens of seconds. Proper heat release is needed and very big heat sinks and a powerful fans are needed. In actual operation, step the power supply down to about 6V by DC/DC converter before input to the add-on board really in need of using power supply over 6V to work with the other devices enclosed.

---

## Disclaimer

---

The copyright of this document belongs to our company.

To reprint, copy, change all or parts of this document without our company's permission is prohibited.

The specification, design, the other contents may change without notice and some of them may differ from those of products purchased.

This product is not designed for use of or use embedded in facilities and equipments related to human life that requires a high of reliability, such as medical care, nuclear power, aerospace, transportation so on.

Our company is not responsible for any personal injury or death, fire accidents, damages to society, property losses and troubles by using this product and then to failure of this product.

Our company is not responsible for any personal injury or death, fire accidents, damages to society, property losses and troubles caused by using this product for the above uses

If there is a hidden defect in this product, our company fix the defect or replace it with the same or equal product free from defect, but we are not responsible for damages of the defect.

Our company are not responsible for failure, personal injury or death, fire accidents, damages to society or property losses and troubles caused by remodeling, modification or improvement.

Contents of this document is made with every possible precaution, but just in case there is any questions, errors or omissions, please contact us.

Contact to

---

# NEKORISU

NEKORISU Co., LTD.

2-16-2 TAKEWARA ALPHASTATES TAKEWARA 8F  
MATSUYAMA EHIME 790-0053  
JAPAN

Mail: [sales@nekorisu-embd.com](mailto:sales@nekorisu-embd.com)